



LD5 – CW/SSB QRP Transceiver



SDR /DSP

Quick guide manual

Description:

At the development base of the digital signal processing unit, an algorithm is embedded for IQ processing of the channels with phase suppression of the unwanted side-band channel.

Unit CPU \ DSP performs the following functions:

- -----
- Digital signal processing
- Frequency synthesizer
- Full control of the transceiver with direct conversion / SDR /

Applicaton:

Due to its small dimensions and light weight this transceiver is suitable for any portable or stationary operation.

This unit contains:

- -CPU STM32F407,
- -NS -24 bit ADC PCM1803,
- -NS -16 bit DAC CS4338 low hissing amp
- -HF-generator Si570
- -1602-line LCD
- -Matrix of buttons
- -Encoder

The unit has electronic CW Iambic key, SWR meter and output power wattmeter.

Functions that this unit performs are separate and switchable for reception / transmission. They are displayed on the screen display as RX / TX with symbols.

The LD5 is capable of firmware update via USB port. See LNR web page for instructions.

How to order:

LNR Website www.LNRprecision.com

Features

- Emmision Modes: SSB, CW , DIGITAL
- 5W output power typ.
- Very low noise floor due to DDC input stage
- The unit has an electronic CW Iambic A/B keyer, SWR meter and output power wattmeter.
- High stability Si 570 generator
- Split-frequency operation
- PTT can be switched by connecting PTT to ground
- RX/TX switching:
 - push PTT input to ground
 - AF VOX
- Output SWR indicator
- Optimal output power indicator
- Integrated Sequencer
- TX 3 band EQ – presets for bass, middle and treble boost

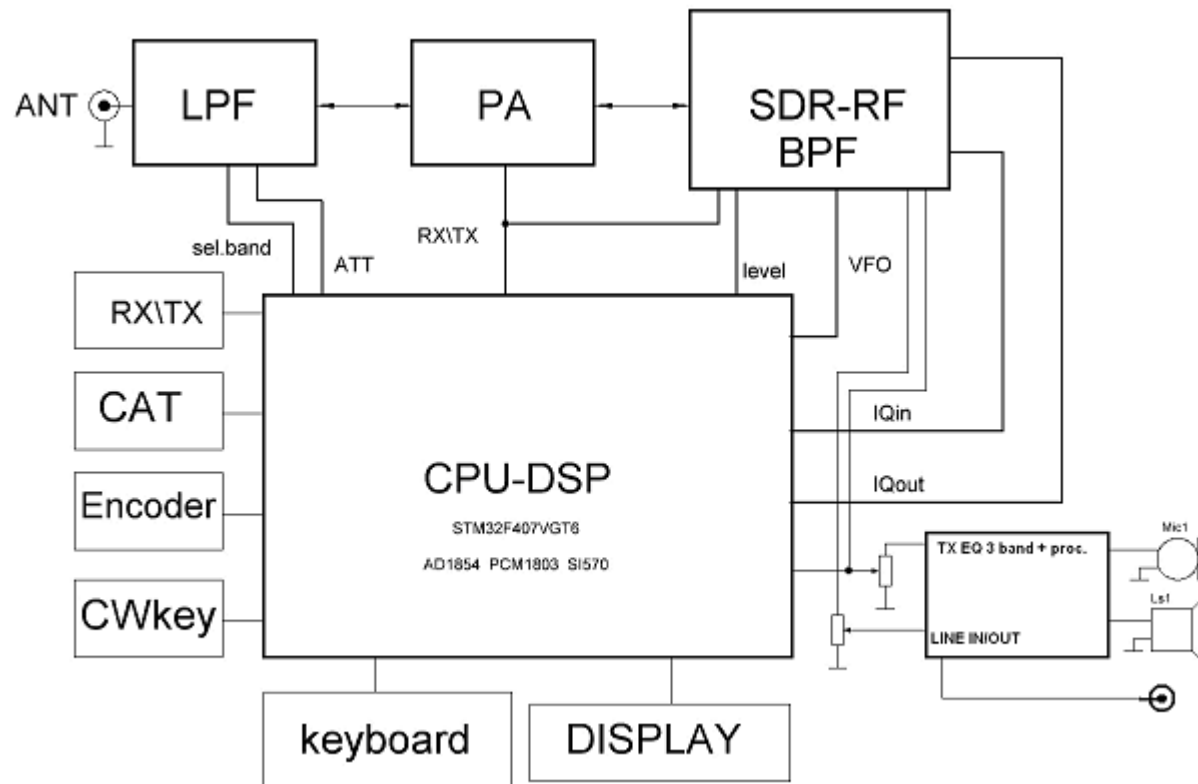

Block diagram

Specifications		
General		
Frequency range	7000 kHz - 22 MHz	40, 30, 20, 17 and 15 meter operation
Modes	USB, LSB, CW, CW-R, DIGITAL	DATA:CAT -USB jack : CW, PSK, RTTY, SSTV - 3.5mm jack
Power	5W output in CW / SSB	
Frequency Stability	+/- 3 ppm (SI570 defined) typical	

	over 0-50 deg C	
Supply Voltage	10.5V min to 15V max	350Ma receive and 1.5 to 2 A typical in transmit
Push button operation		
LO temp. Stability		+/- 2.5
Antenna	50 ohms	BNC
Dual VFO		
Memory	100 memory storage per band	Memorize frequency, mode, VFO's
Built-in speaker	0.2 watts	
Dimensions	4.724" long X 3.937" wide x 1.957 " tall	
Weight	19.0oz / 0,54kilogram /excluding microphone/	
Iambic key	mode A and mode B	
Pitch CW	Controls CW offset. The sidetone pitch is automatically set to equal the offset	
Notch Filter	Automatic Heterodyne filter for SSB from -6 to -40 db	
Noise reduction	level of attenuation of the noise from 1 to 50- use minimal necessary	
Noise Blanker	adjusted in the range from value 4 to 12 readings depending on interference	
CW VOX	Break in delay in CW – adjustable from 0.1 seconds to 5 seconds	
CW memory keyer	Choose Iambic Mode A or B	
VOICE VOX	VOX Delay adjustable from 0.1 seconds to 5 seconds	
SSB VOX LEVEL	VOX GAIN 10-100 10 IS MOST SENSITIVE	
Filters	8 different filters – 4 of 4 for CW/ SSB - 1-3 factory presets – No.4 adjustable for CW/50-1000Hz/ and SSB/250-3.6KHz	
Compressor SSB	0-20dB	
SSB TX MUTE	Enable= no monitor Disable= monitor	
Transmitter		
Input Power	10.5-13.8 VDC	
Output Power	3.5 – 8W	

Measurement	SWR and Power in numbers or bar	
	supply voltage –real voltage on display	
Two modes CW	Select a hand key or a paddle	
Receiver		
Receive sensitivity	0.2uV	Preamp
Ant Preamp	+12	dB
Spurious response rejection	IMD3 -48Db/ 5W	IMD5 -43dB
ATT	-6 db	

Front panel indicators and functions

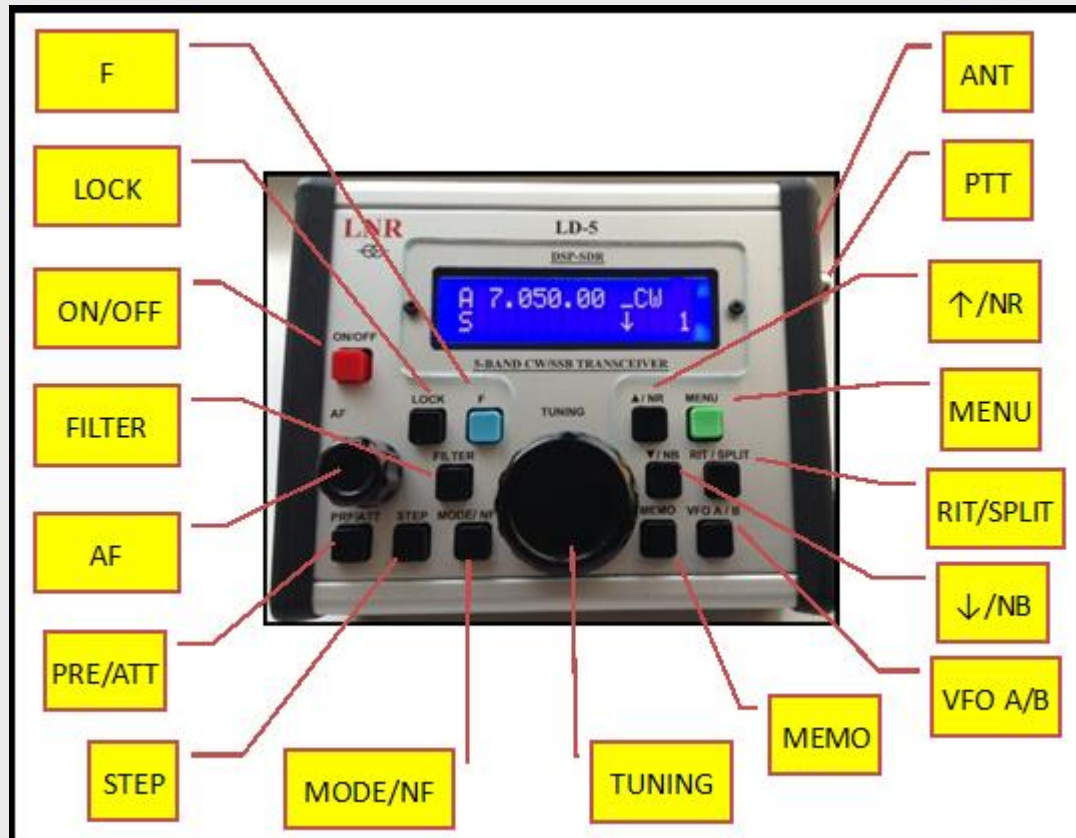

DESCRIPTION of the command buttons

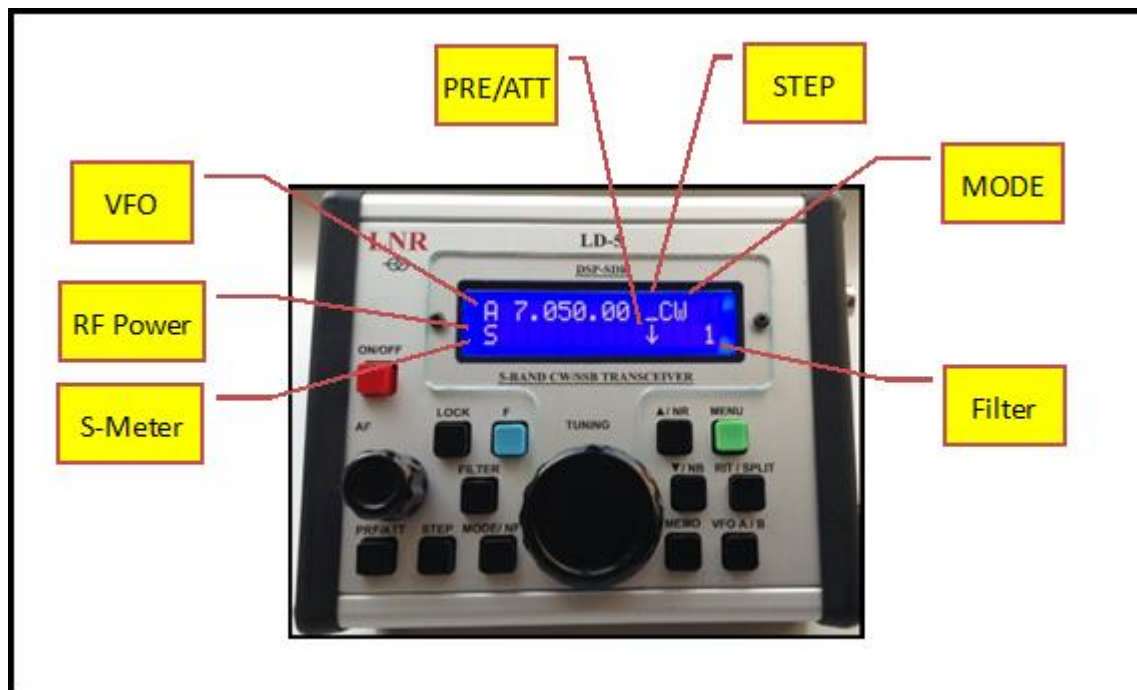

Command	Meaning
ON/OFF	POWER ON/OFF the transceiver
UP Arrow ↑	Change Band higher 7/10/14/18/21. In Menu mode select next menu item
DOWN Arrow ↓	Change band lower. In menu mode select previous menu item.
MODE	Select CW/ CWR/ LSB/ USB/DIGI
VFO	Select either VFO A or B
STEP	Sequential pressing of the STEP button or the Tuning encoder steps through the tuning rate. 1 bar- 1Hz 2 bars=10Hz 3 bars=100Hz 4 bars=1KHz tuning rate.
LOCK	Lock/unlock the tuning dial F symbol appears to the left of the mode designation on LCD

RIT	<p>Receiver Incremental Tuning. This feature allows changing the frequency of the receiver only without effecting the transmit frequency. When RIT is activated an * initially appears to the right of the frequency readout. The * indicates that currently, RIT=0 or RX=TX.</p> <p>While RIT is activated, tuning the VFO BELOW the current frequency is indicated by a < symbol. Similarly, tuning above the center frequency results in a > symbol appearing to the right of the display. RIT remains active until the next ON/OFF power cycle.</p>
PRE/ATT	<p>Sequentially enables preamp (↑) approx. +16dB Preamp off= No arrow attenuator (↓) approx. -10dB</p>
FILTER	<p>Filter #4 is customizable in CW and SSB. CW from 50Hz→ 2400Hz SSB from Low end of 250Hz to High end of 3400Hz. CW: Select Filter #4. Press F then Filter. Use the VFO knob to adjust bandwidth SSB: Select Filter #4. Press F then Filter. Use the VFO knob to adjust the low end. Press RIT to adjust the High end. Pressing RIT again will toggle back to low end adjust. Press Filter when complete.</p>
Memory Storage	<p>A total of 100 memories are available. All features (e.g. Mode/NB/NR/Preamp etc) are stored along with the frequency. To store a frequency in memory, first tune it in using the VFO. Set Mode and any other features you wish to store. Press MEMO Use the VFO knob to bring up the memory location you wish to store: 0-99</p> <p>Press the Down Arrow ↓ Press MEMO again</p>
Memory Recall	<p>To recall a stored memory channel; Press MEMO Use the VFO to dial up the desired memory location</p> <p>Press the Up arrow ↑ Press Memo again</p>

MENU Settings

Enter MENU MODE by pressing MENU button and exit the menu mode by pressing the MENU again after set up. Most of the functions, related to receiving or transmitting, can be changed by values and monitored via monitor in real time.

MENU	Default menu settings
AGC	AGC speed from 1-20. 1 is the slowest and 20 the fastest
PITCH CW	Sidetone and CW offset pitch. Changes take effect when you exit Menu mode
CW SPEED	5 to 60 WPM. Speed change takes effect when you exit Menu mode.
WEIGHT CW KEY	Adjusts the ratio of dash length to dot length: 2> 1; 2.5> 1; 3> 1; 3.5> 1; 4> 1; 4.5> 1 3:1 is standard
CW VOX	Controls break in delay. Steps in 100mSec from 100mSec to 5 seconds
REVERSE CW KEY	Change which side of the paddle is dot and which side is dash.
CW KEY TYPE	Two options: SIMPLE= hand key. AUTO= Paddle.
IAMBIC MODE	Allows user to switch from Iambic mode A to Iambic mode B
NOTCH FILTER	Adjusts notch depth from -6 dB to -40dB Changes can be observed while in Menu mode.
NOISE BLANKER	Adjustable using tuning knob from 4 to 12. 4 is maximum blanking, 12 is minimum. Changes can be heard while in Menu mode.
NOISE REDUCTION	Menu range from 1 to 100 with 1 being the least. If NR is activated from the front panel (F + NR) you can observe the effect within the Menu.
S-METER MODE	Two modes: Bar Graph or readout in uV.
TX METER	Two options: Bar Graph (Scaler) or Watts (Number)
SHOW TX	Two options: Power in Watts or VSWR
POWER TX	Adjusts power out. Settings from 10 to 100. Typically, a 10 setting is 1W and a 100 setting is 5W
LED MODE	Two options: Forever= LCD backlight always on. Auto= backlight turns on for 3 seconds whenever a front panel switch or encoder is activated. Backlight off saves 40mA of current drain.
SSB TX MUTE	SSB TX Monitor. Two options: Enable and Disable
SSB COMPRESSOR	SSB Mic compression from 1 to 100.
SSB VOX	adjustment of VOX delay for SSB - DISABLE is off, Adjustable from 100mSec to 5 seconds in 100mSec steps
VOX LEVEL	Adjusts VOX gain in SSB mode.
TX EQ	3 options: Accentuate the Lows, Highs or Midrange. LowF /HiF/ MediumF
GAIN TX DIG	Setting from 1-9.8 using the VFO knob. This function controls the AF Gain in Digital mode
SQUELCH	Settings 0-100. A 0 (zero) setting essentially turns squelch off.



FUNCION SETTINGS = PUSHING F + :

RIT

On virtual intermediate frequency (VIF) – can be set from the main menu from 5000 to 10000 hertz. Identified as arrows on the upper right corner of the display ->. VIF is working as a main working feature and must be switched on permanently. DIRECT CONVERSION should be used as an option.

On any VFO- when you push RIT an asterisk appears as shown:



A14.020.00* CW
S9- ===== ↑ 1

When you move frequency up , an arrow will appear to the right:



A14.020.10> CW
S9- ===== ↑ 1

When you move frequency down , an arrow will appear to the left:



A14.019.90< CW
S9- ===== ↑ 1

SPLIT OPERATION

SPLIT MODE- if you want to receive on 14020.00 and transmit on 14030.00:
SET frequency on VFO A 14020.00 and on VFO B 14030.00
REMEMBER, first VFO chosen is an RX frequency:
PUSH RIT button, and then follow RIT MODE :

A14.020.00* CW
S9- ===== ↑ 1

PUSH VFO A/B until VFO B appears, with reflecting RX frequency arrow to the left

B14.020.00< CW
S9- ===== ↑ 1

If you switch on TX, the frequency on VFO B will appear – 14030.00

B14.030.00< CW
PO:5.1 Watt

You will notice that VFO A frequency can move up/down, but VFO B is fixed on TX.
If you wish to reverse the frequency, exit RIT Mode and switch to VFO B, then push RIT and then VFO A.
Notice the arrow shows pointing to the right

B14.030.00> CW
S9- ===== ↑ 1

On TX you will see this :

A14.020.00> CW
PO:5.2 Watt

To enter main MENU press the MENU button. After making menu changes, press MENU again to exit MENU mode.

**ADDITIONAL FEATURES USING THE (F)UNCTION KEY
FUNCTION SETTINGS = PUSHING F +**

MENU	Press (F)unction and then Menu. This changes the 2 nd line of the LCD display from S meter reading to monitoring the supply voltage. Pressing (F)unction and Menu again returns to S meter reading.
UP (↑)	Press (F)unction and then ↑ turns on Noise Reduction at whatever level is preset in the main Menu. The display will show a "R" to the left of the Filter # on the LCD display. Press (F)unction and ↑ again to turn off Noise Reduction
MODE	Available only in SSB mode. Press (F)unction and then Mode to enable the notch filter at whatever level has been preset in the main Menu. Press (F)unction and then Mode again to turn off the notch filter. The letter "N" will display to the left of the Filter #.
DOWN (↓)	Press (F)unction and then ↓ to turn on the Noise Blanker at whatever level has been preset in the main Menu. The letter "B" will display to the left of the Filter # on the LCD display
FILTER	Filter #4 is customizable in CW and SSB. CW from 50Hz→ 2400Hz SSB from Low end of 250Hz to High end of 3400Hz. CW: Select Filter #4. Press F then Filter. Use the VFO knob to adjust bandwidth SSB: Select Filter #4. Press F then Filter. Use the VFO knob to adjust the low end. Press RIT to adjust the High end. Pressing RIT again will toggle back to low end adjust. Press Filter when complete.

SERVICE MODE – It is strongly recommended to contact LNR Support before entering service mode

Entry into service mode	To enter Service Mode – power OFF the radio and then press Power while holding down the (F)unction . Release (F)unction as soon as the Firmware page comes up. To display Service Mode options, press (F)unction and then Menu. The first screen you should see is IF DSP 5006 Note: Some Main Menu functions will be reset to factory default after Service Mode (corrected in firmware 1.77.1 update) Do NOT adjust RX or TX IQ.
	RX and TX IQ and Ref VFO are set differently for each LD-5 transceiver. Write these values down in your manual.

BASIC SETTINGS

F button and then press the MENU button and moving with UP / DOWN and RIT	
IF DSP	Virtual gap frequency from 5006 to 10013 Hz / recommended to use a low-frequency virtual
V PWR	If you have an accurate voltmeter, you can adjust the displayed voltage reading. Normally, should not need adjustment.
REF VFO	Used to calibrate the LCD frequency display. A higher reading will move the display UP in frequency. Factory set.
MULT VFO	Factory set- should not be changed
STARTING FREQUENCY	Low end frequency of selected band change with tuning knob
END FREQUENCY	High end frequency of selected band change with tuning knob
S METER	If you have a calibrated signal generator you can set the S meter in uV.
RX IQ	Setting the mirror channel correcting the phase and amplitude of IQ for each band separately on RX "- minimum reading – has two modes- fast and slow for quick setting and fine – switched with STEP. Each transceiver is factory default recorded on the accompanying document
FILTER SSB	Setup filters from 1 to 3 for each type of work. Changing the filter with the push button "Filter"
FILTER CW	Allows user to change the bandwidth of the first three CW filters. While in Service Mode, press Menu. Select Filter 1 CW and redefine the BW with the main tuning knob. Step to the next filter by pressing FILTER etc. Exit Menu mode to save.
AGC DSP	on / off AGC -SHOULD ALWAYS BE SET TO ENABLE
SHOW S METER	Options are: Enable and Disable. Disable turns off the S meter
FILTER TX SSB	Adjustment of bandwidth in the transmit mode /FROM 150 Hz to 3600Hz/ -. Changing adjustment of the upper frequency
FILTER TX CW	With the push button "RIT/VIF" adjustment of bandwidth in the transmit mode /FROM 50 Hz to 1000Hz/ - soft CW manipulation 50 – 180 Hz. BELL SOUND
LEVEL TX	Adjusts the calibration of the internal wattmeter. Do not change unless you have an accurate wattmeter. The lower the number, the higher the wattmeter reads.

DESCRIPTION of the settings in transmit mode

PWR / VTT	
POWER TX	This feature allows independent setting of output power on a band by band basis. Select the band you wish to change output power on Enter service mode and dial up POWER TX. Use the VFO knob to change the power level as indicated on the 2 nd line of the display. 100=minimum power. 1000=maximum power.
TX IQ	Correcting amplitude and phase balance in IQ channel – in the transmit mode for each band separately For this purpose we need to have a separate receiver on the frequency and listen to the unwanted side band channel – set on minimal hearing. Factory setting on all bands is : A 0.0000 F 0,0000
TX EQ	3 band audio presets on transmit only: bass, middle. Treble boost

DESCRIPTION of the current settings

/ Those settings are directly accessible by pressing MENU /	
AGC SPEED	Adjustable from 1-20. 1 is the slowest AGC decay.
PITCH CW	CW TX offset. The offset value is matched by the side tone frequency. Range from 400-1000Hz
NOTCH FILTER	Heterodyne auto notch filter from -6dB to -40dB. Available only in SSB mode.
NOISE BLANKER	Adjustable from 4-12. 4 is maximum blanking. Changes can be heard while in Menu mode.
NOISE REDUCTION	Level of reduction of the noise from 1 to 100- use minimal necessary
S-METER MODE	Shows scale bars or S-units in microvolt's
LED MODE	Choose Forever (always ON) or Auto (backlight comes on temporarily when any knob or button is pressed)
CW SPEED	Adjustable from 5-60 WPM
WEIGHT CW KEY	Adjusts the ratio of dash length to dot length: 2> 1; 2.5> 1; 3> 1; 3.5> 1; 4> 1; 4.5> 1 3:1 is standard
CW VOX	DELAY mode in CW - 100 milliseconds to 5000 milliseconds / 5 seconds. DISABLE turns off CW so accidentally hitting the key will not TX.
COMPRESS TX	Compression microphone from 0 to 100%. 100%= 20dB compression.
REVERSE CW KEY	Reverses the sides of the paddle that create DOT/DASH. Sometimes called right hand or left hand keying.
TX METER	The LCD display will show TX power via a bar graph or actual watts. SHOW TX MUST be set to TX power first. Otherwise SWR will be displayed.
SHOW TX	Choices are to display TX power in watts or SWR.
POWER TX	Regulation in mW from 10% to 100%
SSB MUTE	Allows for monitoring transmitted SSB signal.

DIGITAL MODES

IMPORTANT – Make sure to connect the USB, Power Cord and Antenna before powering on the radio. Then Power ON the Radio. Finally, start up your software program:



In order to operate digital mode or interface with computer, utilize the Line IN/OUT jack and cable. The radio has typical levels for audio signals similar to other amateur radios.

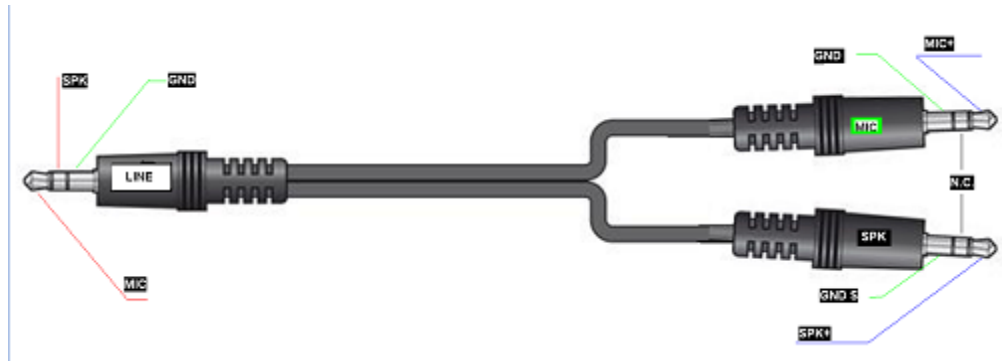

SWR Protection

The radio has a built-in ALC SWR protection - when SWR does not exceed 3:1 - there is no change in output power. But at a greater SWR, the protection gradually lowers the power output, and at SWR = 10 - the output power is only 1%.

=====

EXPANDED RECEIVE CAPABILITIES

The LD-5 can be set to receive 160M and 80M. At this time, this is for receive only, no TX.

1. Put the LD-5 on 40M.
2. Enter Service Menu
3. Use the UP and DOWN arrow keys to bring up (Begin Frequency 2 Band)
4. Using the VFO knob to tune to 1.8MHz. Pressing the Step button will enable faster QSX.
5. Exit Service mode
6. Use the VFO knob to tune to 7.300MHz and as you go higher the VFO will roll over to 1.8MHz.
7. Select a frequency and mode on 160M and store this frequency into a memory location.
8. Tune up to 80M and do the same for a memory location.
9. Tune to 40M and store a memory location.

When the 40M band is selected with the UP and DOWN arrows, use the Memory function to recall 160, 80 or 40M bands.

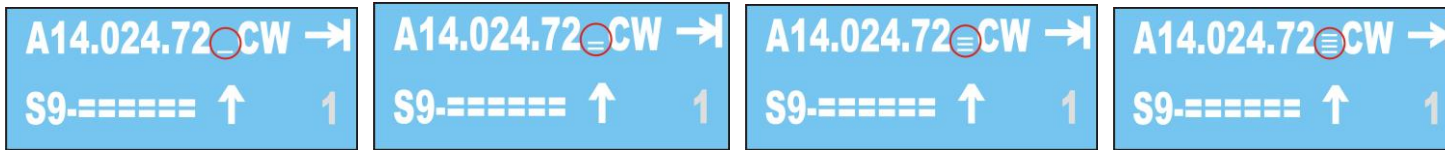

TUNING BAR STEPS IN CW MODE



PREAMP ENABLE

NORMAL

ATTENUATOR ENABLE

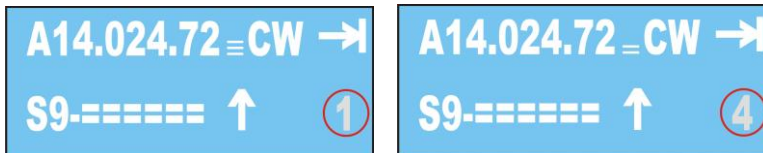

EXAMPLE CW FILTER #1

EXAMPLE CW FILTER #4

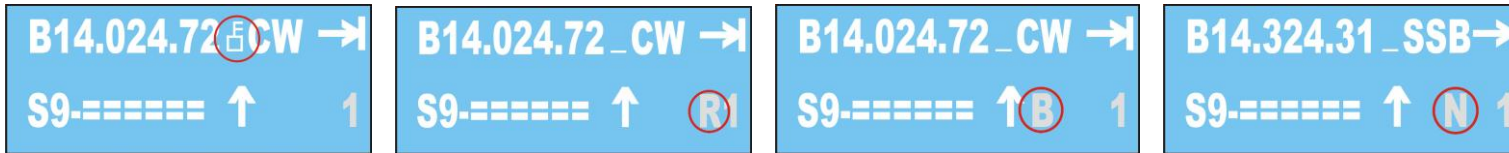

KEYBOARD LOCKED

NOISE REDUCTION= **R**

NOISE BLANKER= **B**

NOTCH FILTER= **N**